







**CÓDIGO:**  
**U026 - BRONZE**

## FICHA TÉCNICA

Esquinero Marco 45 Mm. Espesor 1.4 Mm. Largo 5.85 Mts. Acabado Anodizado Bronze 15 Micron. (D3-P1-A1-04-01)

Esquinero 90° para marco de 45 mm			
<b>Código: U026</b>		Peso (kg/m): 0.815	
Perimetro Total (mm): 430		Espesor general = 1.4	
Perimetro Ext. (mm): 247		Aleación-Temple = 6063 T5	
a	---	b	---
c	---	d	---

Acabados disponibles:

					
Anodizado natural	Lacado Blanco	Anodizado Negro	Anodizado Bronce	Lacado texturizado Gris oscuro	Lacado de madera

**LONGITUD 5.85 MTS** \*Consultar disponibilidad de diferentes acabados.

**Código de producto:** U026 - BRONZE

**Marca:** CARBONE





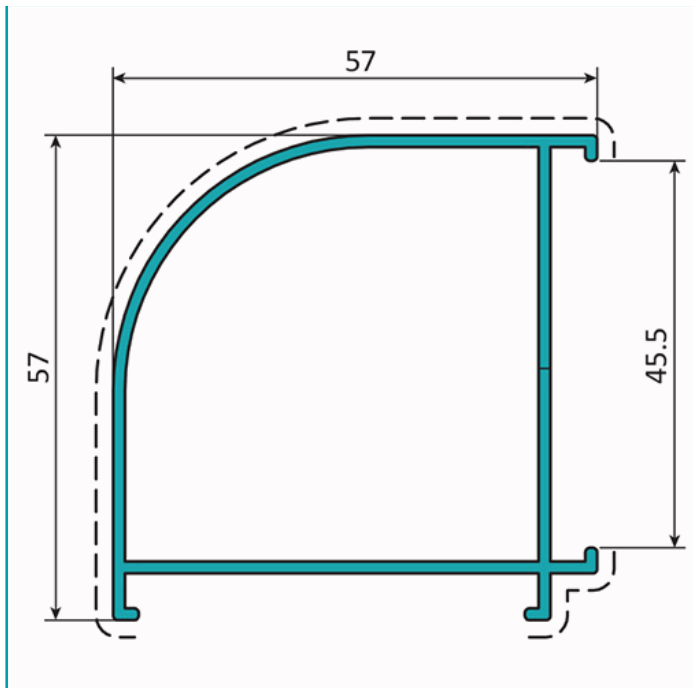

**Peso (Kg):** 5 Kg

**Tipo:** Serie Perimetral Abatible de 45 mm



Esquinero 90° para marco de 45 mm			
<b>Código: U026</b>		Peso (kg/m): 0.815	
Perimetro Total (mm): 430		Espesor general = 1.4	
Perimetro Ext. (mm): 247		Aleación-Temple = 6063 T5	
a	---	b	---
c	---	d	---

Acabados disponibles:

					
Anodizado natural	Lacado Blanco	Anodizado Negro	Anodizado Bronce	Lacado texturizado Gris oscuro	Lacado de madera

**LONGITUD 5.85 MTS** \*Consultar disponibilidad de diferentes acabados.